

48 V Input	12 V Output	25 A Current	300 W Power	2000 V dc Isolation	Quarter-brick DC-DC Converter
----------------------	-----------------------	------------------------	-----------------------	-------------------------------	-----------------------------------------

The BusQor® BQ50120QTx25 bus converter is a next-generation, board-mountable, isolated, fixed switching frequency DC-DC converter that uses synchronous rectification to achieve extremely high conversion efficiency. The power dissipated by the converter is so low that a heat sink is not required, which saves cost, weight, height, and application effort. The BusQor series provides an isolated step down voltage from 48V to 12V intermediate bus with no regulation in a standard quarter-brick module. BusQor converters are ideal for creating the mid-bus voltage required to drive point-of-load (non-isolated) converters in intermediate bus architectures.

BusQor®

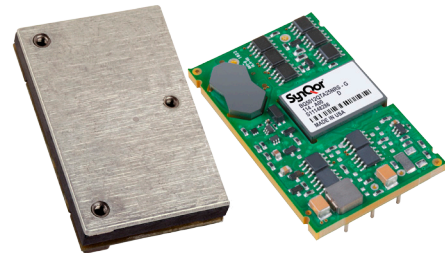

BQ50120QTx25 Model

Operational Features

- High efficiency, 96.1% at full rated load current
- Delivers up to 25 A (300 Watts) of output current (power) with minimal derating - no heat sink required
- Operating input voltage range: 42-53 V
- Fixed frequency switching provides predictable EMI performance
- No minimum load requirement

Control Features

- On/Off control referenced to input side (positive and negative logic options are available)
- Current sharing allowed without the use of any external circuitry.

Safety Features

- CAN/CSA C22.2 No. 60950-1
- UL 60950-1
- EN 60950-1

Mechanical Features

- Industry standard quarter-brick pin-out configuration
- Size: 1.45" x 2.3" (36.8 x 58.4 mm), height: 0.467" (11.86 mm)
- Total open frame weight: 1.5 oz (42 g)

Protection Features

- Input under-voltage lockout and over-voltage shutdown protect against abnormal input voltages
- Output current limit and short circuit protection (auto recovery)
- Thermal shutdown

Contents

Open Frame Mechanical Diagram	2
Baseplated Mechanical Diagram	3
Electrical Characteristics	4
Compliance & Testing	6
Technical Figures	7
Applications Section	10
Ordering Information	14

Input: 42-53 V
Output: 12 V
Current: 25 A
Package: Quarter-brick

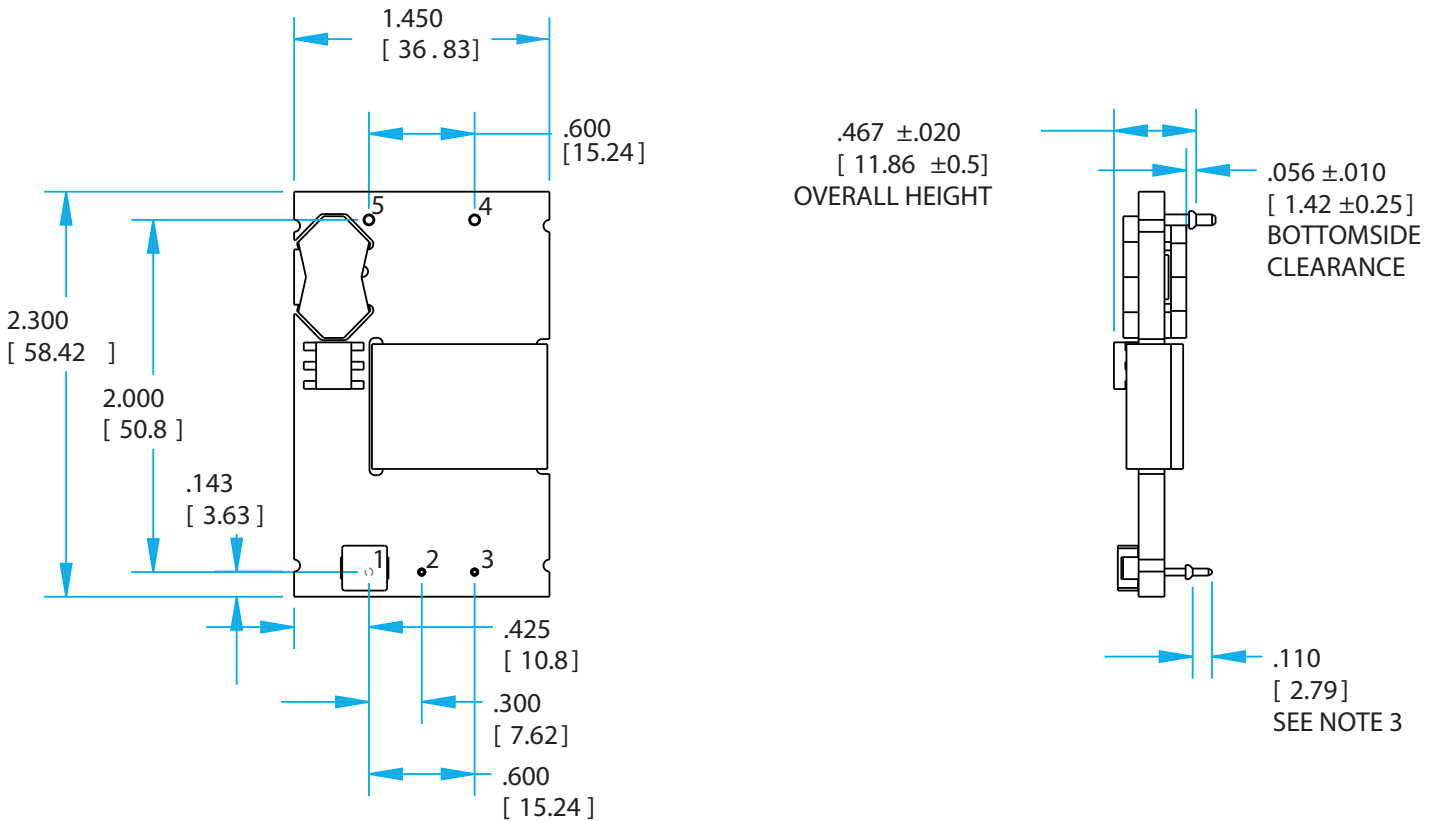

NOTES

- 1) Pins 1-3 are 0.040" (1.02 mm) diameter with 0.080" (2.03 mm) diameter standoff shoulders.
- 2) Pins 4-5 are 0.062" (1.57 mm) diameter with 0.100" (2.54 mm) diameter standoff shoulders.
- 3) Other pin lengths available. Recommended pin length is 0.03" (0.76 mm) greater than the PCB thickness.
- 4) All Pins: Material - Copper Alloy
Finish: Matte Tin over Nickel plate
- 5) Undimensioned components are shown for visual reference only.
- 6) All dimensions in inches (mm)
- 7) Tolerances: x.xx +/-0.02 in. (x.x +/-0.5 mm)
x.xxx +/-0.010 in. (x.xx +/-0.25 mm)
- Weight: 1.5 oz (42 g) typical
- 8) Workmanship: Meets or exceeds IPC-A-610C Class II
- 9) UL/TUV standards require a clearance of 0.04" (1.02 mm) around primary areas of the module.
- 10) The flanged pins are designed to permit surface mount soldering (allowing to avoid the wave soldering process) through the use of the flanged pin-in-paste technique.

PIN DESIGNATIONS

Pin	Name	Function
1	Vin(+)	Positive input voltage
2	ON/OFF	Logic control input to turn converter on/off
3	Vin(-)	Negative input
4	Vout(-)	Negative output
5	Vout(+)	Positive output

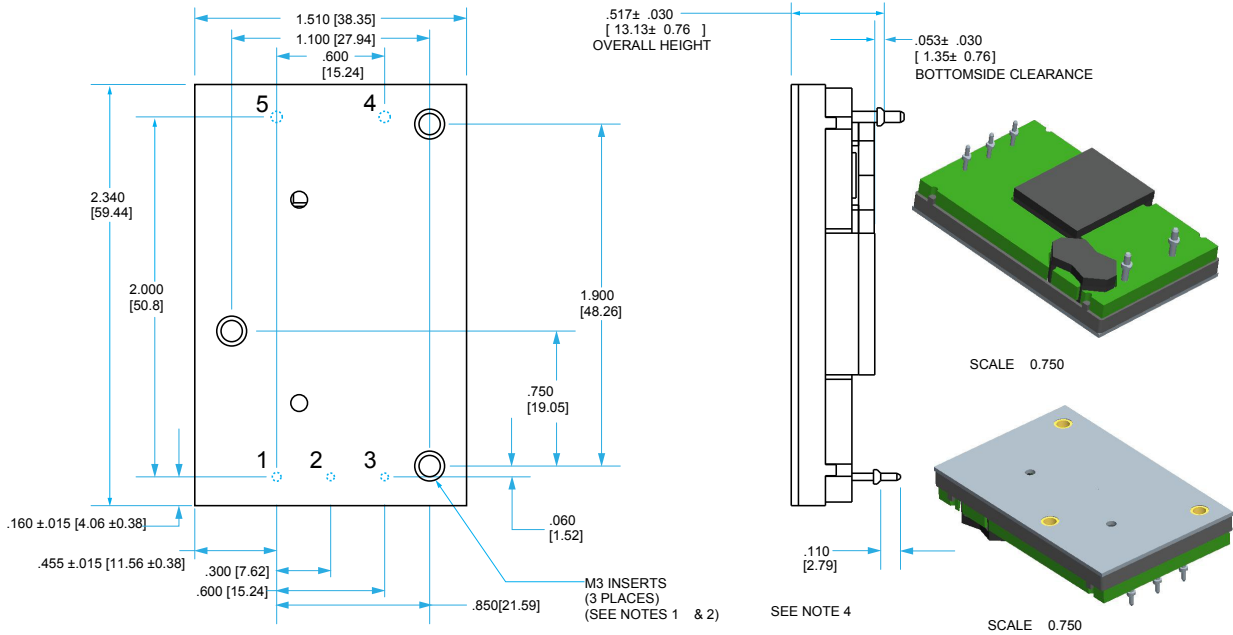

NOTES

- 1) M3 screws used to bolt unit's baseplate to other surfaces such as heatsinks must not exceed 0.10" (2.54 mm) depth below the surface of the baseplate.
- 2) Applied torque per screw should not exceed 6in-lb (0.7 nm)
- 3) Baseplate flatness tolerance is 0.004" (.10 mm) TIR for surface
- 4) Other pin extension lengths available
- 5) Pins 1-3 are 0.040" (1.02 mm) dia. with 0.080" (2.03 mm) dia. standoff shoulders
- 6) Pins 4 and 5 are 0.062" (1.57 mm) dia. with 0.100" (2.54 mm) dia. standoff shoulders
- 7) All pins: Material: Copper Alloy
Finish: Matte Tin over Nickel plate
- 8) Undimensioned components are shown for visual reference only
- 9) Weight: 2.7 oz (78 g) typical
- 10) All dimensions in inches(mm)
Tolerances: x.xx in +/-0.02 (x.x mm +/-0.5 mm)
x.xxx in +/-0.010 (x.xx mm +/-0.25 mm)

PIN DESIGNATIONS

Pin	Name	Function
1	Vin(+)	Positive input voltage
2	ON/OFF	Logic control input to turn converter on/off
3	Vin(-)	Negative input
4	Vout(-)	Negative output
5	Vout(+)	Positive output



Technical Specification

Input: 42-53 V
Output: 12 V
Current: 25 A
Package: Quarter-brick

BQ50120QTx25 Electrical Characteristics

Ta = 25 °C, airflow rate = 300 LFM, Vin = 48 V dc unless otherwise noted; full operating temperature range is -40 °C to +100 °C ambient temperature with appropriate power derating. Specifications subject to change without notice.

Parameter	Min.	Typ.	Max.	Units	Notes & Conditions
ABSOLUTE MAXIMUM RATINGS					
Input Voltage					
Non-Operating	-1		60	V	Continuous
Operating			56	V	Continuous
Isolation Voltage (Input to Output)			2000	V	Basic insulation, Pollution Degree 2
Operating Temperature	-40		100	°C	
Storage Temperature	-45		125	°C	
Voltage at ON/OFF input pin	-2		12	V	
INPUT CHARACTERISTICS					
Operating Input Voltage Range	42	48	53	V	
Input Under-Voltage Lockout					
Turn-On Voltage Threshold		39.5		V	
Turn-Off Voltage Threshold		38.0		V	
Lockout Voltage Hysteresis		1.5		V	
Input Over-Voltage Shutdown				V	
Turn-Off Voltage Threshold		55.0		V	Vin when unit will shut down
Turn-On Voltage Threshold		54.0		V	Vin when unit turns on after shutdown event
Maximum Input Current			6.8	A	100% Load, 42 Vin
No-Load Input Current	0.07		0.11	A	
Disabled Input Current		7.5	15	mA	
Inrush Current Transient Rating			0.01	A ² S	I ² T rating of external fuse should be higher
Input Reflected-Ripple Current		5		mA	RMS through 10 µH inductor; Figures 12 & 14
Input Terminal-Ripple Current		75	100	mA	RMS, full load; Figures 12 & 13
Recommended Input Fuse (see Note 1)			12	A	Fast blow external fuse recommended
Input Filter Component Values (CL/C)		1\1\4.4		µF\µH\µF	Internal values
Recommended External Input Capacitance		47		µF	Typical ESR 0.1 - .02 Ω, see Figure 12
OUTPUT CHARACTERISTICS					
Output Voltage Set Point		12.00		V	48 Vin, no load
Output Voltage Regulation					
Over Line		± 10 \ 1.2		%\V	Figure 4
Over Load		± 4.1 \ 500		%\mV	Figure 4
Over Temperature		± 1.7 \ 200		%\mV	Figure 4
Total Output Voltage Range	9.7		13.3	V	Over sample, line, load, temperature & life
Output Voltage Ripple and Noise					20 MHz bandwidth; see Note 2; Figures 12 & 15
Peak-to-Peak		100	150	mV	Full load, see Figures 12 & 15
RMS		25	40	mV	Full load, see Figures 12 & 15
Operating Output Current Range	0		25	A	Subject to thermal derating; Figures 5 - 8
Output DC Current-Limit Inception		34		A	Output Voltage 10% Low; Figure 16
Output DC Current-Limit Shutdown Voltage		8		V	
Current Share Accuracy (2 units paralleled)		± 10		mA	% of rated output current
Back-Drive Current Limit while Disabled		10		mA	Negative current drawn from output
Maximum Output Capacitance			3,000	µF	12 Vout at 25 A Resistive Load
EFFICIENCY					
100% Load		96.1		%	Figure 1
50% Load		96.4		%	Figure 1

BQ50120QTx25 Electrical Characteristics (continued)

Ta = 25 °C, airflow rate = 300 LFM, Vin = 48 V dc unless otherwise noted; full operating temperature range is -40 °C to +100 °C ambient temperature with appropriate power derating. Specifications subject to change without notice.

Parameter	Min.	Typ.	Max.	Units	Notes & Conditions
DYNAMIC CHARACTERISTICS					
Output Voltage during Load Current Transient					
Step Change in Output Current (0.1 A/μs)		200		mV	50% to 75% to 50% Iout max; Figure 11
Settling Time		100		μs	To within 1% Vout nom
Turn-On Transient					
Turn-On Time (with 5 mF output capacitance)		2.5		μs	Half load, Vout = 90% nom.; Figures 9 & 10
Start-Up Inhibit Time		2		ms	Figure E
Output Voltage Overshoot		5		%	3 mF load capacitance, Iout = 12.5 A resistive
ISOLATION CHARACTERISTICS					
Isolation Voltage (dielectric strength)		2000		V	See Absolute Maximum Ratings
Isolation Resistance		30		MΩ	
Isolation Capacitance (input to output)			470	pF	See Note 3
TEMPERATURE LIMITS FOR DERATING					
Semiconductor Junction Temperature			125	°C	Package rated to 150 °C
Board Temperature			125	°C	UL rated max operating temp 130 °C
Transformer Core Temperature			125	°C	See Figures 5 - 8 for derating curves
Maximum Baseplate Temperature, Tb			100	°C	
FEATURE CHARACTERISTICS					
Switching Frequency	127.5	150	172	kHz	
ON/OFF Control (Option P)					Figure B
Off-State Voltage	-1.0		0.8	V	
On-State Voltage	2.4		18	V	
ON/OFF Control (Option N)					Figure B
Off-State Voltage	2.4		18	V	
On-State Voltage	-1.0		0.8	V	
ON/OFF Control (Either Option)					Application notes
Pull-Up Voltage		7.3		V	
Pull-Up Resistance		30		kΩ	
Over-Temperature Shutdown OTP Trip Point		120		°C	Average PCB Temperature
Over-Temperature Shutdown Restart Hysteresis		10		°C	
Load Current Scale Factor		800			See App Note: Output Load Current Calc.
RELIABILITY CHARACTERISTICS					
Calculated MTBF (Telcordia) TR-NWT-000332		2.7		10 ⁶ Hrs.	TR-NWT-000332; 100% load, 300 LFM, 40 °C Ta
Calculated MTBF (MIL-217) MIL-HDBK-217F		2.0		10 ⁶ Hrs.	MIL-HDBK-217F; 100% load, 300 LFM, 40 °C Ta

Note 1: UL's product certification tests were carried out using 20 A fast blow fuse. Fuse interruption characteristics have to be taken into account while designing input traces. User should ensure that input trace is capable of withstanding fault currents.

Note 2: For applications requiring reduced output voltage ripple and noise, consult SynQor applications support (e-mail: support@synqor.com)

Note 3: Higher values of isolation capacitance can be added externally to the module.



Technical Specification

Input: 42-53 V
Output: 12 V
Current: 25 A
Package: Quarter-brick

Compliance & Testing

Parameter	Notes & Conditions
-----------	--------------------

STANDARDS COMPLIANCE

CAN/CSA C22.2 No. 60950-1

UL 60950-1

EN 60950-1

Note: An external input fuse must always be used to meet these safety requirements. Contact SynQor for official safety certificates on new releases or download from the SynQor website.

Parameter	# Units	Test Conditions
-----------	---------	-----------------

QUALIFICATION TESTING

Life Test	32	95% rated Vin and load, units at derating point, 1000 hours
Vibration	5	10-55 Hz sweep, 0.060" total excursion, 1 min./sweep, 120 sweeps for 3 axis
Mechanical Shock	5	100 g minimum, 2 drops in x, y and z axis
Temperature Cycling	10	-40 °C to 100 °C, unit temp. ramp 15 °C/min., 500 cycles
Power/Thermal Cycling	5	Toperating = min to max, Vin = min to max, full load, 100 cycles
Design Marginality	5	Tmin-10 °C to Tmax+10 °C, 5 °C steps, Vin = min to max, 0-105% load
Humidity	5	85 °C, 85% RH, 1000 hours, continuous Vin applied except 5 min/day
Solderability	15 pins	MIL-STD-883, method 2003

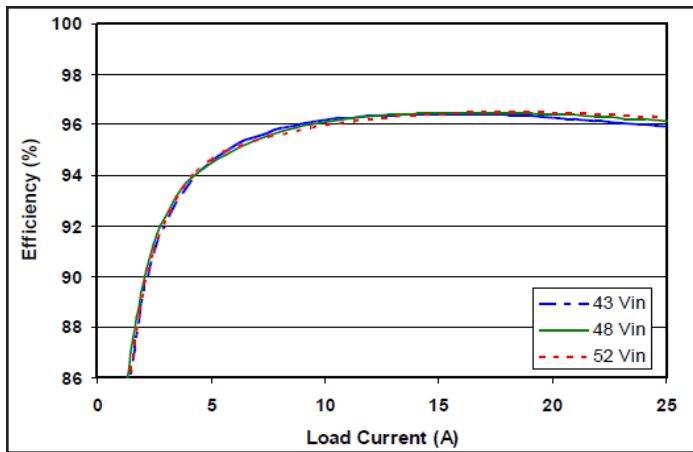

Figure 1: Efficiency at nominal output voltage vs. load current for minimum, nominal, and maximum input voltage at 25 °C.

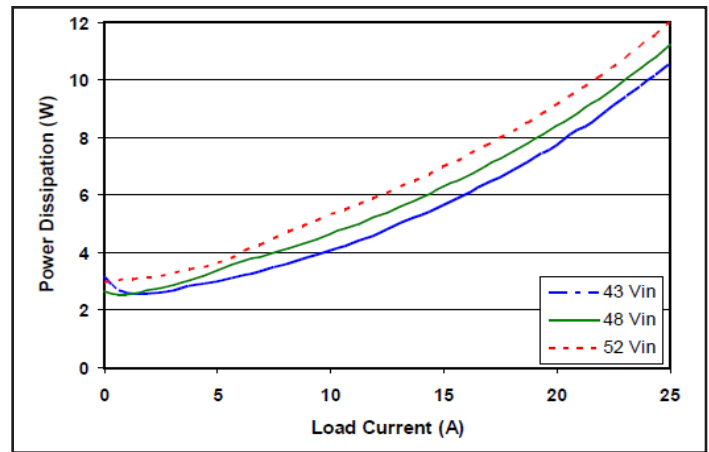

Figure 2: Power dissipation at nominal output voltage vs. load current for minimum, nominal, and maximum input voltage at 25 °C.

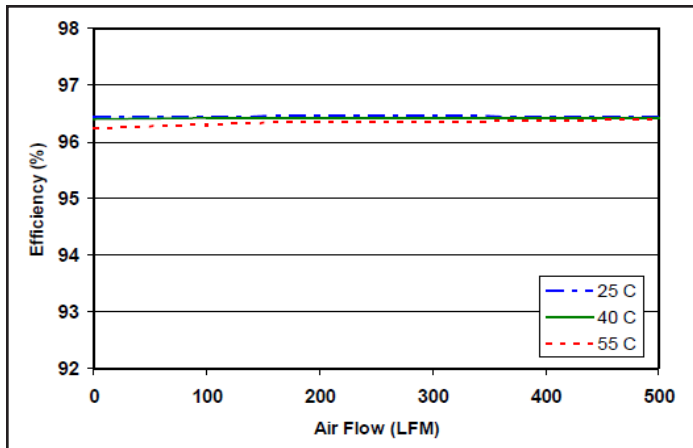

Figure 3: Efficiency at nominal output voltage and 60% rated power vs. airflow rate for ambient air temperatures of 25 °C, 40 °C, and 55 °C (nominal input voltage).

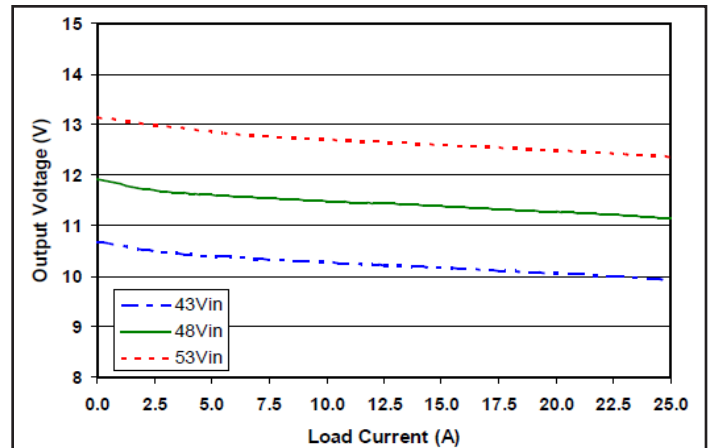

Figure 4: Output voltage regulation vs. load current for minimum, nominal, and maximum input voltage at 25 °C.

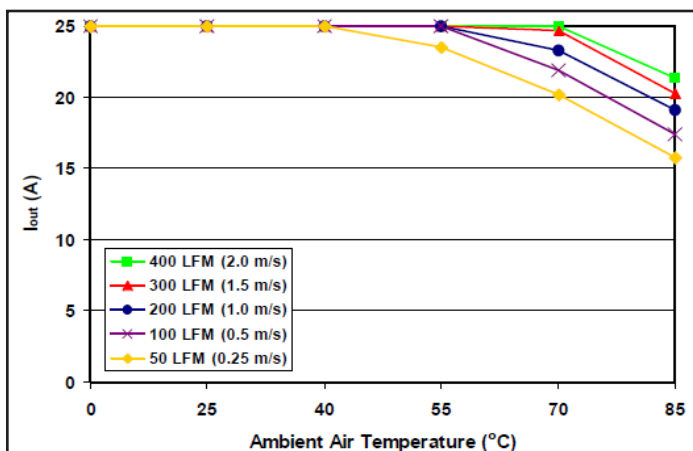

Figure 5: Maximum output power derating curve vs. ambient air temperature for airflow rates of 50 LFM through 400 LFM with air flowing from pin 3 to pin 1 (nominal input voltage).

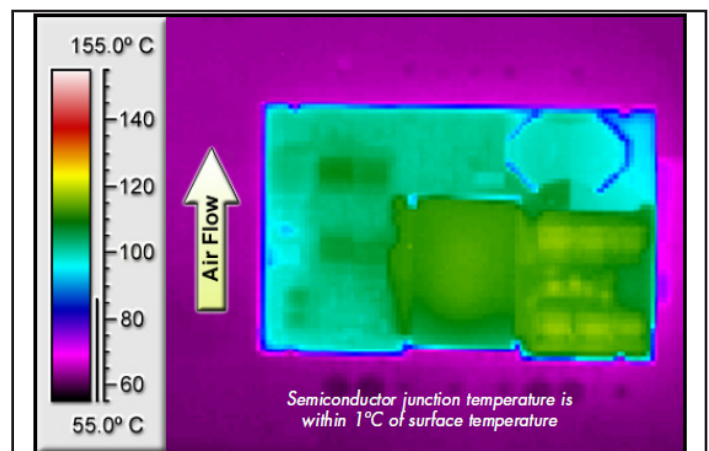

Figure 6: Thermal plot of converter at 25 A load current (300 W) with 55 °C air flowing at the rate of 200 LFM. Air is flowing across the converter from pin 3 to pin 1 (nominal input voltage).

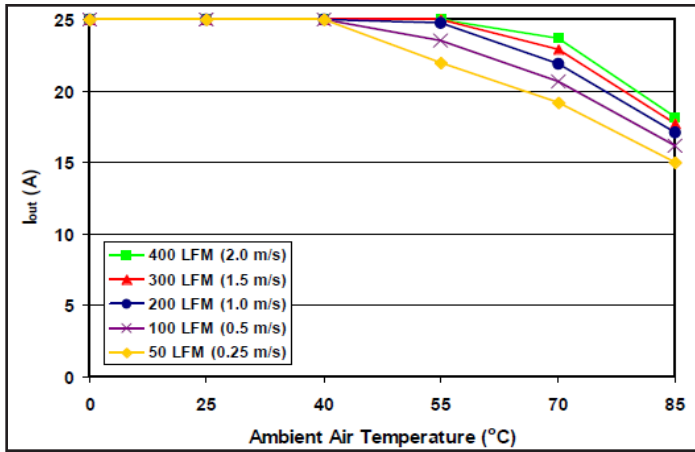

Figure 7: Maximum output power derating curves vs. ambient air temperature for airflow rates of 50 LFM through 400 LFM with air flowing across the converter from input to output (nominal input voltage).

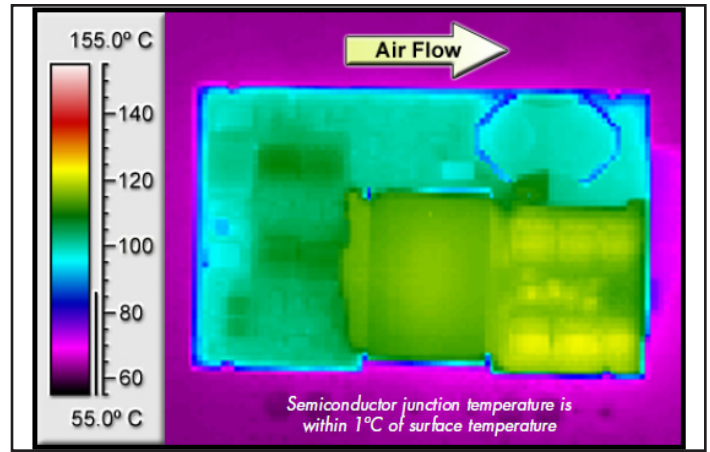

Figure 8: Thermal plot of converter at 25 A load current (300 W) with 55 °C air flowing at the rate of 200 LFM. Air is flowing across the converter from input to output (nominal input voltage).

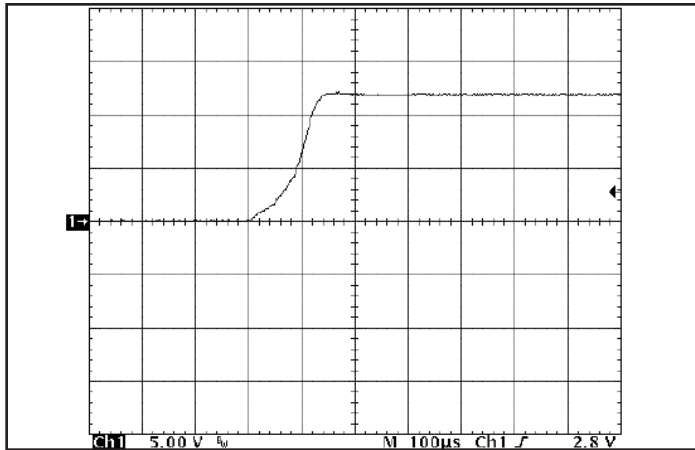

Figure 9: Turn-on transient at full load (resistive load) (100 μs/div). Ch 1: V_{out} (5 V/div)

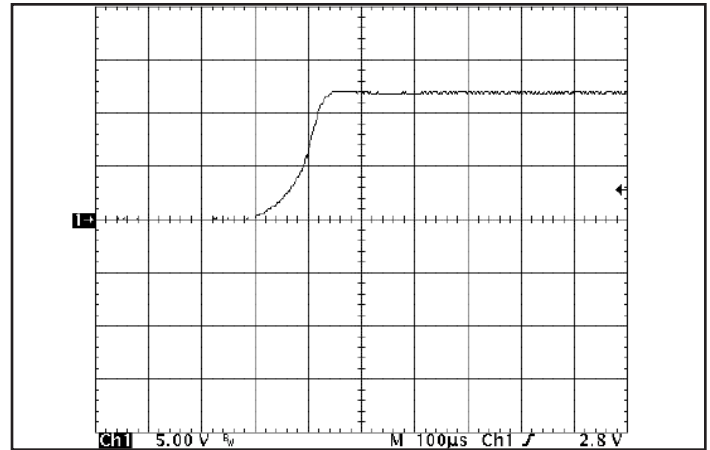

Figure 10: Turn-on transient at zero load (100 μs/div). Ch 1: V_{out} (5 V/div)

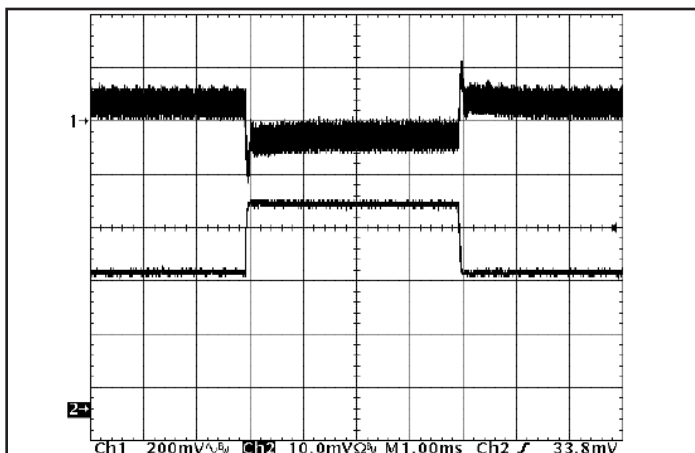

Figure 11: Output voltage response to step-change in load current (50%-75%-50% of $I_{out(max)}$; $dI/dt = 0.1 A/\mu s$). Load cap: 15 μF, 100 mΩ ESR tantalum cap and 1 μF ceramic cap. Top trace: V_{out} (200 mV/div), Bottom trace: I_{out} (5 A/div).

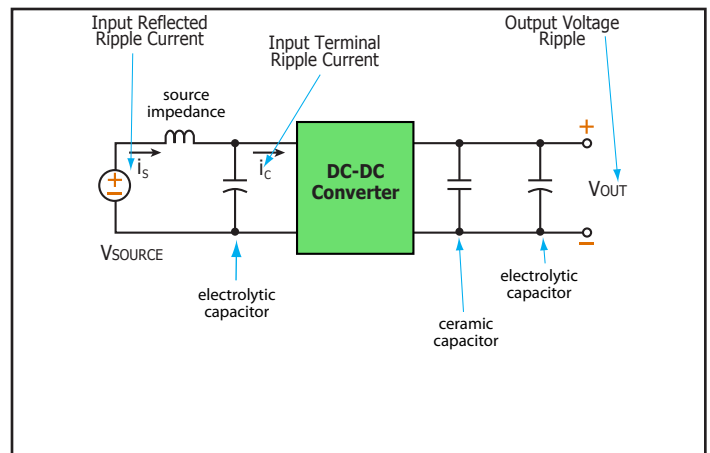

Figure 12: Test set-up diagram showing measurement points for Input Terminal Ripple Current (Figure 13), Input Reflected Ripple Current (Figure 14) and Output Voltage Ripple (Figure 15).

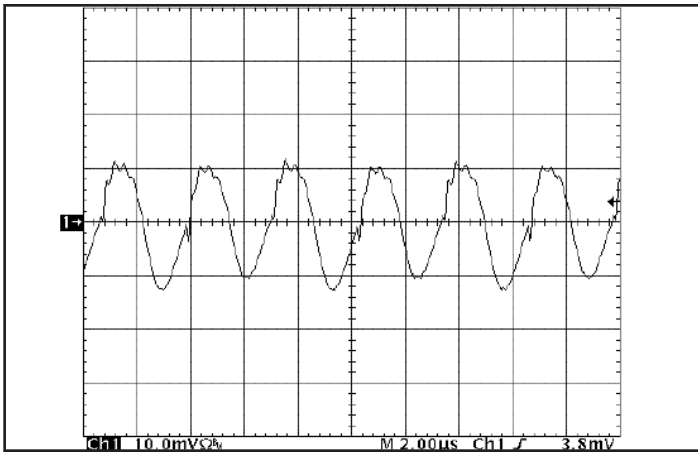

Figure 13: Input Terminal Ripple Current, i_c , at full rated output current and nominal input voltage with $10\ \mu\text{H}$ source impedance and $47\ \mu\text{F}$ electrolytic capacitor ($100\ \text{mA/div}$). See Figure 12.

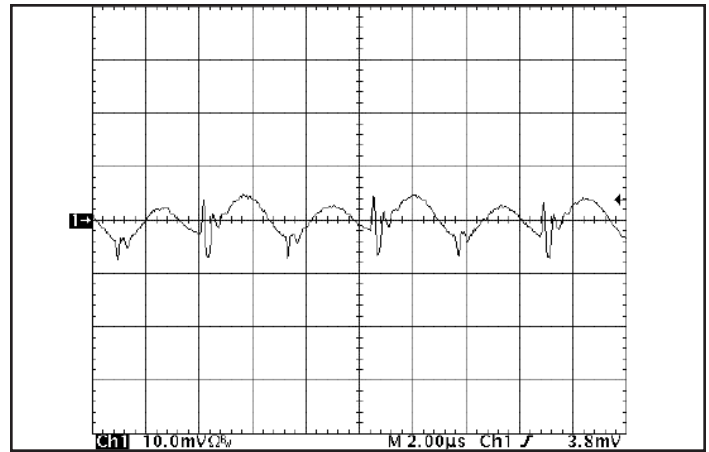

Figure 14: Input reflected ripple current, i_s , through a $10\ \mu\text{H}$ source inductor at nominal input voltage and rated load current ($5\ \text{mA/div}$). See Figure 12.

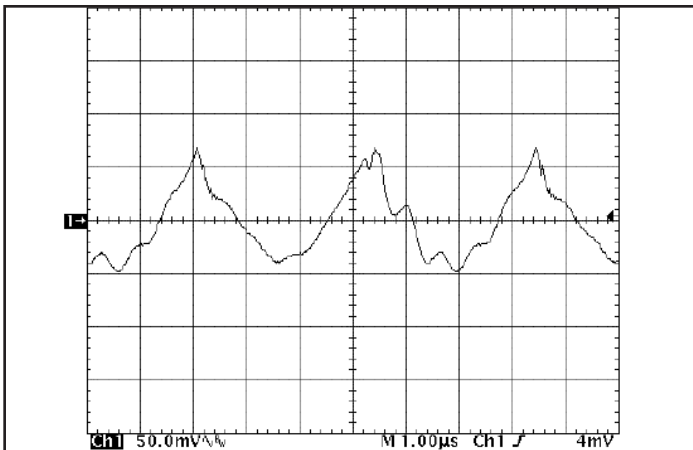

Figure 15: Output voltage ripple at nominal input voltage and rated load current ($50\ \text{mV/div}$). Load capacitance: $1\ \mu\text{F}$ ceramic capacitor and $15\ \mu\text{F}$ tantalum capacitor. Bandwidth: $20\ \text{MHz}$. See Figure 12.

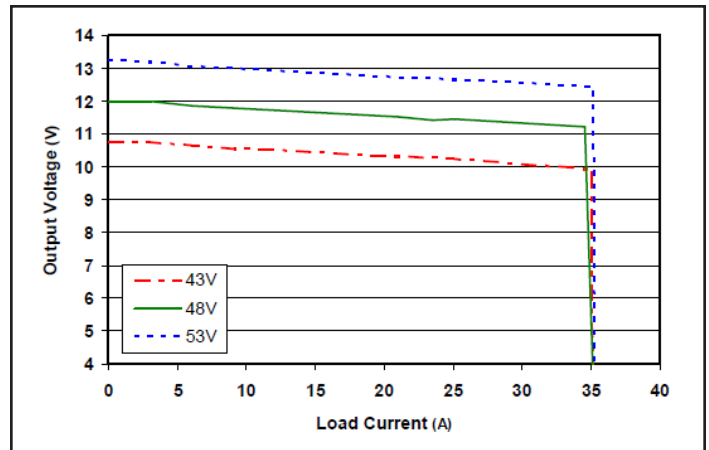

Figure 16: Output voltage vs. load current showing typical current limit curves and converter shutdown points.

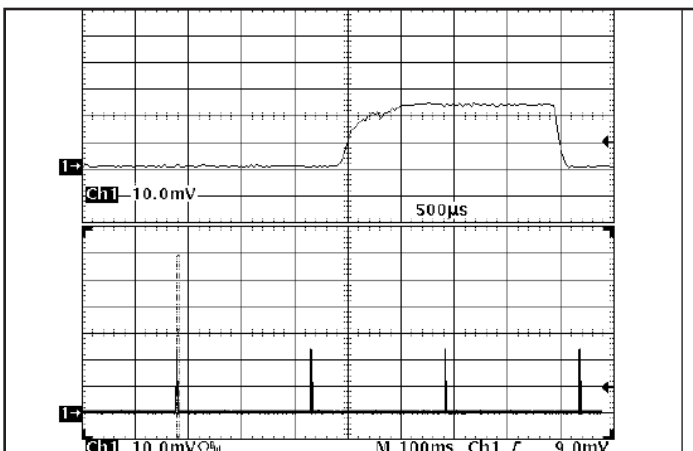

Figure 17: Load current ($50\ \text{A/div}$) as a function of time when the converter attempts to turn on into a $1\ \text{m}\Omega$ short circuit. Top trace ($500\ \mu\text{s/div}$) is an expansion of the on-time portion of the bottom trace.

BASIC OPERATION AND FEATURES

With voltages dropping and currents rising, the economics of an Intermediate Bus Architecture (IBA) are becoming more attractive, especially in systems requiring multiple low voltages. IBA systems separate the role of isolation and voltage scaling from regulation and sensing. The BusQor series bus converter provides isolation and an unregulated voltage step down in one compact module, leaving regulation to simpler, less expensive non-isolated converters.

In Figure A below, the BusQor module provides the isolation stage of the IBA system. The isolated bus then distributes power to the non-isolated buck regulators to generate the required voltage levels at the points of load. In this case, the bucks are represented with SynQor's NiQor series of non-isolated DC/DC converters. In many applications requiring multiple low voltage outputs, significant savings can be achieved in board space and overall system costs

When designing an IBA system with bus converters, the designer can select from a variety of bus voltages. While there is no universally ideal bus voltage, most designs employ one of the following: 12 V, 9 V, 7.5 V, 5 V, or 3.3 V. Higher bus voltages can lead to lower efficiency for the buck regulators but are more efficient for the bus converter and provide lower board level distribution current. Lower bus voltages offer the opposite trade offs.

SynQor's 12 Vout BusQor module acts as a true dc transformer. The output voltage is proportional to the input voltage, with a specified "turns ratio" or voltage ratio, plus minor drop from the internal resistive losses in the module. When used in IBA systems, the output variation of the BusQor must be in accordance with the input voltage range of the non-isolated converters being employed.

The BusQor architecture is very scalable, meaning multiple bus converters can be connected directly in parallel to allow current sharing for higher power applications.

CONTROL FEATURES

REMOTE ON/OFF (Pin 2): The ON/OFF input, Pin 2, permits the user to control when the converter is on or off. This input is referenced to the return terminal of the input bus, Vin(-). There are two versions of the converter that differ by the sense of the logic used for the ON/OFF input.

In the positive logic version, the ON/OFF input is active high (meaning that a high turns the converter on). In the negative logic version, the ON/OFF signal is active low (meaning that a low turns the converter on). Figure B is a detailed look of the internal ON/OFF circuitry.

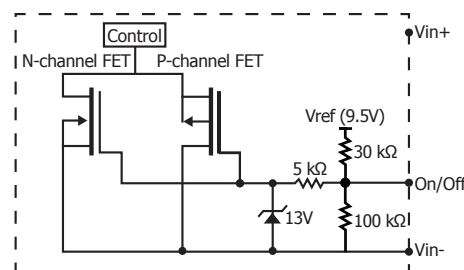

Figure B: Internal ON/OFF pin circuitry

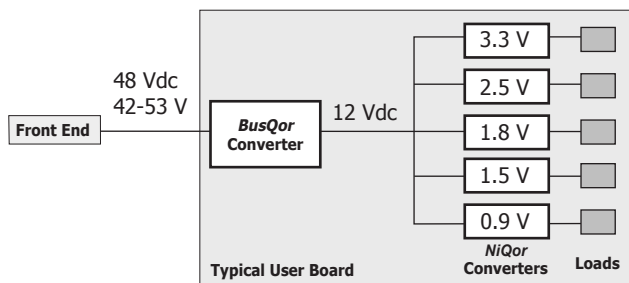

Figure A: Example of Intermediate Bus Architecture using BusQor bus converter and NiQor non-isolated converters

PROTECTION FEATURES

Input Under-Voltage Lockout: The converter is designed to turn off when the input voltage is too low, helping avoid an input system instability problem, described in more detail in the application note titled "Input System Instability". The lockout circuitry is a comparator with DC hysteresis. When the input voltage is rising, it must exceed the typical Turn-On Voltage Threshold value (listed on the specification page) before the converter will turn on. Once the converter is on, the input voltage must fall below the typical Turn-Off Voltage Threshold value before the converter will turn off. Also see Figure E.

Output Current Limit: The output of the BusQor module is electronically protected against output overloads. When an overload current greater than the "DC Current-Limit Inception" specification is drawn from the output, the output shuts down to zero volt in a period of 0.04 ms typical (see Figure C). The shutdown period lasts for a typical period of 250 ms (Figure D) after which the BusQor tries to power up again (10 ms). If the overload persists, the output voltage will go through repeated cycles of shutdown and restart with a duty cycle of 4% (On) and 96% (Off) respectively. The BusQor module returns (auto resetting) to normal operation once the overload is removed. The BusQor is designed to survive in this mode indefinitely without damage and without human intervention.

Output Short Circuit Protection: When the output of the BusQor module is shorted, a peak current of typically 120 A will flow into the short circuit for a period of about 2 ms. The output of the BusQor will shutdown to zero for ~ 250 ms (Figure D). At the end of the shutdown period the BusQor module tries to power up again. If the short circuit persists, the output voltage will go through repeated cycles of shutdown and restart with a duty cycle of 1 % (On) and 99 % (Off) respectively. The BusQor module returns (auto resetting) to normal operation once the short circuit is removed. The BusQor is designed to survive in this mode indefinitely without damage and without human intervention.

In the Auto resetting mode, also referred to as "Hiccup" mode, the power drawn from the 48 V input is about 5 Watts, most of which is dissipated into the external fault. It is important that copper traces and pads from the output circuit be designed to withstand the short term peaks, although the average input current into the fault may be as low as 0.1 A typical. See Figure 17 for appropriate waveform.

Over-Temperature Shutdown: A temperature sensor on the converter senses the average temperature of the module. The thermal shutdown circuit is designed to turn the converter off when the temperature at the sensed location reaches the Over-Temperature Shutdown value. It will allow the converter to turn on again when the temperature of the sensed location falls by the amount of the Over-Temperature Shutdown Restart Hysteresis value.

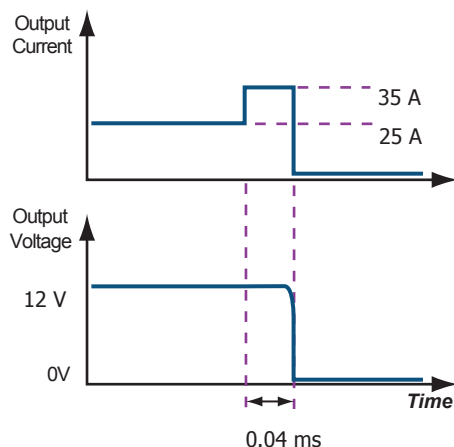

Figure C: Output Overload protection diagram (not to scale)

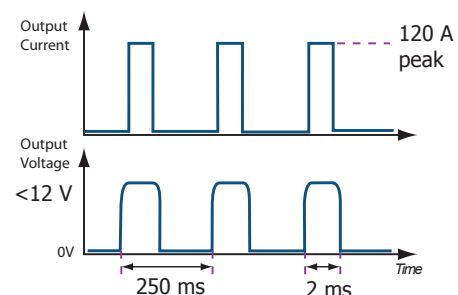

Figure D: Output Short Circuit and Auto-Resetting protection diagram (not to scale)

APPLICATION CONSIDERATIONS

Start-Up Inhibit Period: Figure E details the Start-Up Inhibit Period for the BusQor module. At time t_0 , when V_{in} is applied with On/Off pin asserted (enabled), the BusQor output begins to build up. Before time t_1 , when the input voltage is below the UVL threshold, the unit is disabled by the Input Under-Voltage Lockout feature. When the input voltage rises above the UVL threshold, the Input Under-Voltage Lockout is released, and a typical Startup Inhibit Period of 3 ms is initiated. The output builds up to 90% of the nominal value of 12 V in a period of 0.42 ms typical (50% load).

At time t_2 , when the On/Off pin is de-asserted (disabled), the BusQor output instantly drops to 0 V. Fall time from 12 V to 0 V is dependent on output capacitance and any parasitic trace inductance in the output load circuit.

At time t_3 , when the On/Off pin is re-asserted (enabled), the BusQor module output begins to build up after the inhibit period of 0.35 ms typical has elapsed.

Refer to the Control Features section of the data sheet for details on enabling and disabling methods for N and P logic type modules.

Component Keep Out Area: Keep out areas for components not referenced to the Primary circuit are shown in shaded areas in Figure F. The keep out areas shown are consistent with UL's requirements for Basic Insulation of 0.04" (40 mils) for Pollution degree 2. User should consult UL standards for other insulation classes and operating environments.

For applications that require mounting parts BELOW the BusQor module, one should be aware of potential high levels of electromagnetic interference, in addition to safety keep out. Users are advised to consult SynQor Applications engineering in such applications.

Copper Keep Out Area: Keep out areas shown in Figure F are to be observed for Top layer copper traces and vias. Internal layers buried one or more layers may be exempt, depending on the PCB material grade and thickness. Users are advised to consult UL standards for details.

All layers including top and bottom, are subject to the keep out areas shown around Primary pins of BusQor module. Actual keep outs along the surface (Creepage) may vary depending on the PCB material CTI. Users are advised to consult UL standards for details.

Bridging Components: Bridging components like EMI filter capacitors required to be placed as close as possible to the BusQor module for optimum performance must observe the clearance/creepage requirements of 0.04" (40 mils) between pads to maintain compliance to UL standards for the overall power system.

Note: Referenced keep out widths are adequate to withstand UL's Basic Insulation Dielectric strength tests for approved PCB materials. Applications requiring Double or Reinforced insulation must double the keep out widths shown in Figure F. Keep out areas shown have standard margins above UL's minimum requirements.

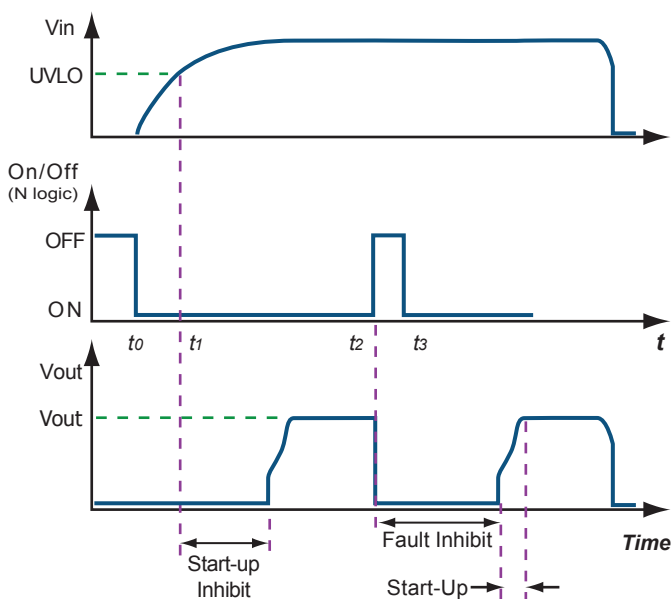

Figure E: Power Up/Down Diagram (not to scale) showing Start-Up Inhibit Period

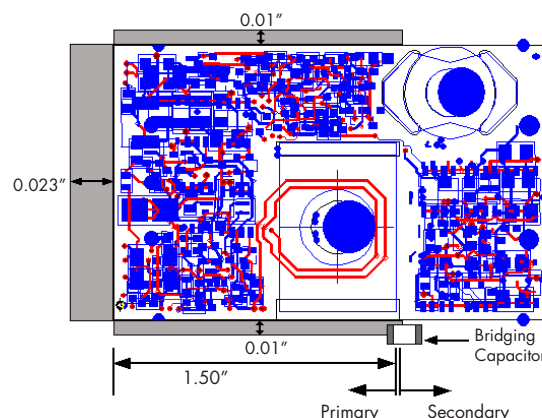

Figure F: Keep Out Areas for BusQor module

Input: 42-53 V
Output: 12 V
Current: 25 A
Package: Quarter-brick

Output Load Current Calculation: The BusQor series allows the converter output load to be measured without adding a current loop or external shunt resistor to the designer's PCB board under test. On the top side of the BusQor converter is a current sense resistor as shown in Figure G. The output load current is proportional to the voltage drop across this sense resistor. This calculation is detailed below. A current sense resistor referenced to the primary input is used in the equation below to calculate the output load current.

$$I_{load} = (VR_{sense}(load) - VR_{sense}(no\ load)) \times 800$$

where:

$$I_{load} = \text{output load current}$$

$$VR_{sense}(load) = \text{voltage across the sense resistor with converter under load}$$

$$VR_{sense}(no\ load) = \text{voltage across the sense resistor with converter at zero load}$$

The number 800 is a "Load Current Scale Factor" for this product, valid only for $V_{in} = 48\text{ V}$. Hence, measurement should be made at this input voltage.

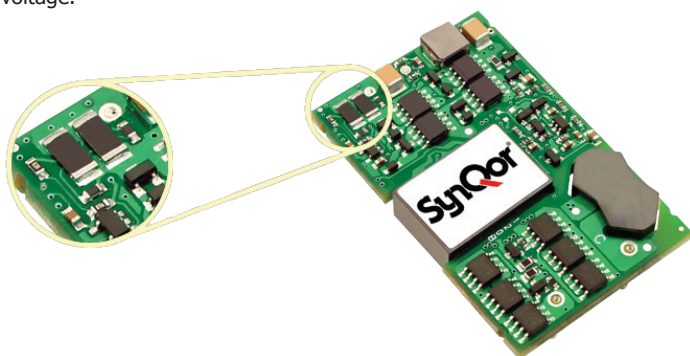

Figure G: Location of Sense Resistor

The voltage drop across the sense resistor is about 25 mV at full load of 25 A. Therefore, proper measuring techniques must be used to ensure accuracy. A calibrated DMM set to 300 mV is acceptable. Since this measurement is done on the Primary area of the converter, a slight non-linearity may be observed over the load current range. Measurements should be made at 48 V input voltage. Using the Scale Factor referenced above, the error may be on the order of 4%. For more detailed information consult the application note on SynQor's website titled "Output Load Current Calculations".

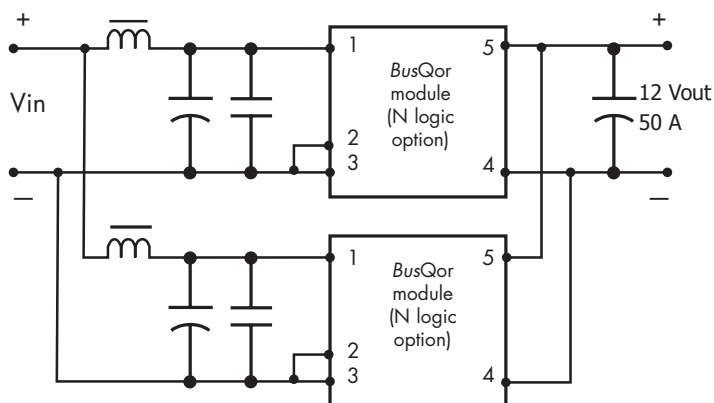

Figure H: BusQor Output Paralleling for increased current output

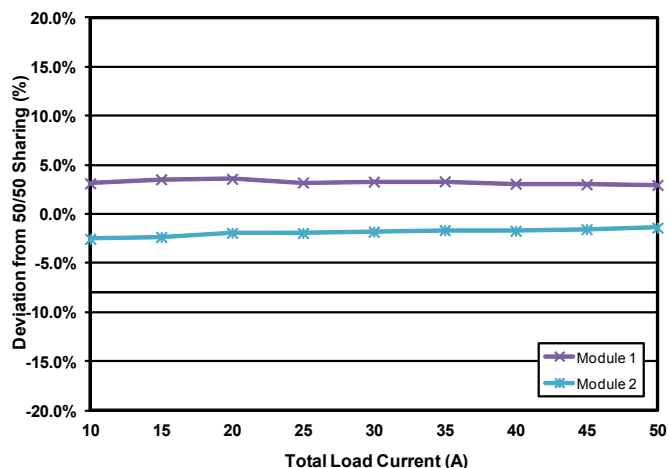

Figure I: Current share performance of 2 paralleled modules

Current Sharing: BusQor modules are designed to operate in parallel without the use of any external current share circuitry. A typical circuit for paralleling two BusQor modules is shown in Figure H. An output capacitor is recommended across each module and located close to the converter for optimum filtering and noise control performance. Dedicated input inductors are recommended but are considered optional. Input capacitors must be located close to the converter module. PCB layout in the input circuit should be such that high frequency ripple currents of each module is restricted to a loop formed by the input capacitors and the input terminals of the BusQor module. See Figure J for details on PCB layout. Contact SynQor application engineering for further assistance on PCB trace design.

The current share performance of two paralleled modules is illustrated in the graph in Figure I. In this graph the percent deviation from ideal sharing (50%) is plotted for each module versus the total output load current at 48 Vin.

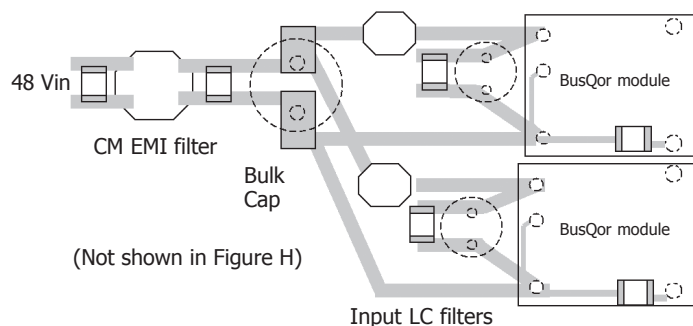

Figure J: Recommended PCB layout for input circuit



Ordering Information

Input: 42-53 V
Output: 12 V
Current: 25 A
Package: Quarter-brick

Part Numbering System

The part numbering system for SynQor's dc-dc converters follows the format shown in the example below.

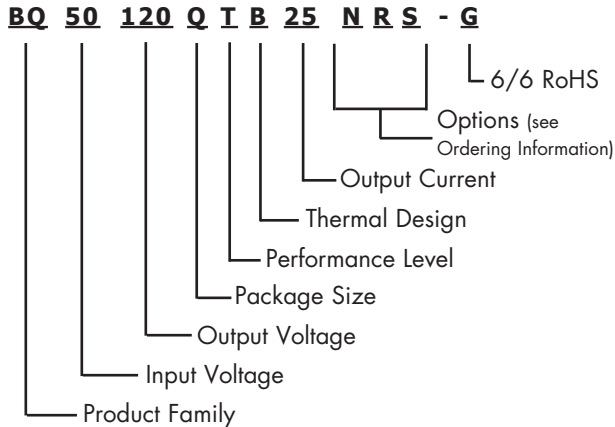

The first 12 characters comprise the base part number and the last 3 characters indicate available options. The "-G" suffix indicates 6/6 RoHS compliance.

Application Notes

A variety of application notes and technical white papers can be downloaded in pdf format from our [website](#).

RoHS Compliance: The EU led RoHS (Restriction of Hazardous Substances) Directive bans the use of Lead, Cadmium, Hexavalent Chromium, Mercury, Polybrominated Biphenyls (PBB), and Polybrominated Diphenyl Ether (PBDE) in Electrical and Electronic Equipment. This SynQor product is 6/6 RoHS compliant. For more information please refer to SynQor's RoHS addendum available at our [RoHS Compliance / Lead Free Initiative web page](#) or e-mail us at rohs@synqor.com.

Contact SynQor for further information and to order:

Phone: 978-849-0600 Toll Free: 888-567-9596 Fax: 978-849-0602

E-mail: power@synqor.com Web: www.synqor.com

Address: 155 Swanson Road, Boxborough, MA 01719 USA

WARRANTY

SynQor offers a three (3) year limited warranty. Complete warranty information is listed on our website or is available upon request from SynQor.

Ordering Information

The tables below show the valid model numbers and ordering options for converters in this product family. When ordering SynQor converters, please ensure that you use the complete 15 character part number consisting of the 12 character base part number and the additional characters for options. Add "-G" to the model number for 6/6 RoHS compliance.

Model Number	Input Voltage	Output Voltage	Max Output Current
BQ50120QT w 25 xyz -G	42-53 V	12 V	25 A

The following options must be included in place of the **wxyz** spaces in the model numbers listed above.

Options Description: w x y z			
Thermal Design	Enable Logic	Pin Style	Feature Set
A - Open Frame B - Baseplated	N - Negative P - Positive	K - 0.110" N - 0.145" R - 0.180" Y - 0.250"	S - Standard

Not all combinations make valid part numbers, please contact SynQor for availability.

PATENTS

SynQor holds numerous U.S. patents, one or more of which apply to most of its power conversion products. Any that apply to the product(s) listed in this document are identified by markings on the product(s) or on internal components of the product(s) in accordance with U.S. patent laws. SynQor's patents include the following:

7,050,309 7,765,687 7,787,261
 8,149,597 8,644,027